

A01 - Axial Head

Component Parts Breakdown

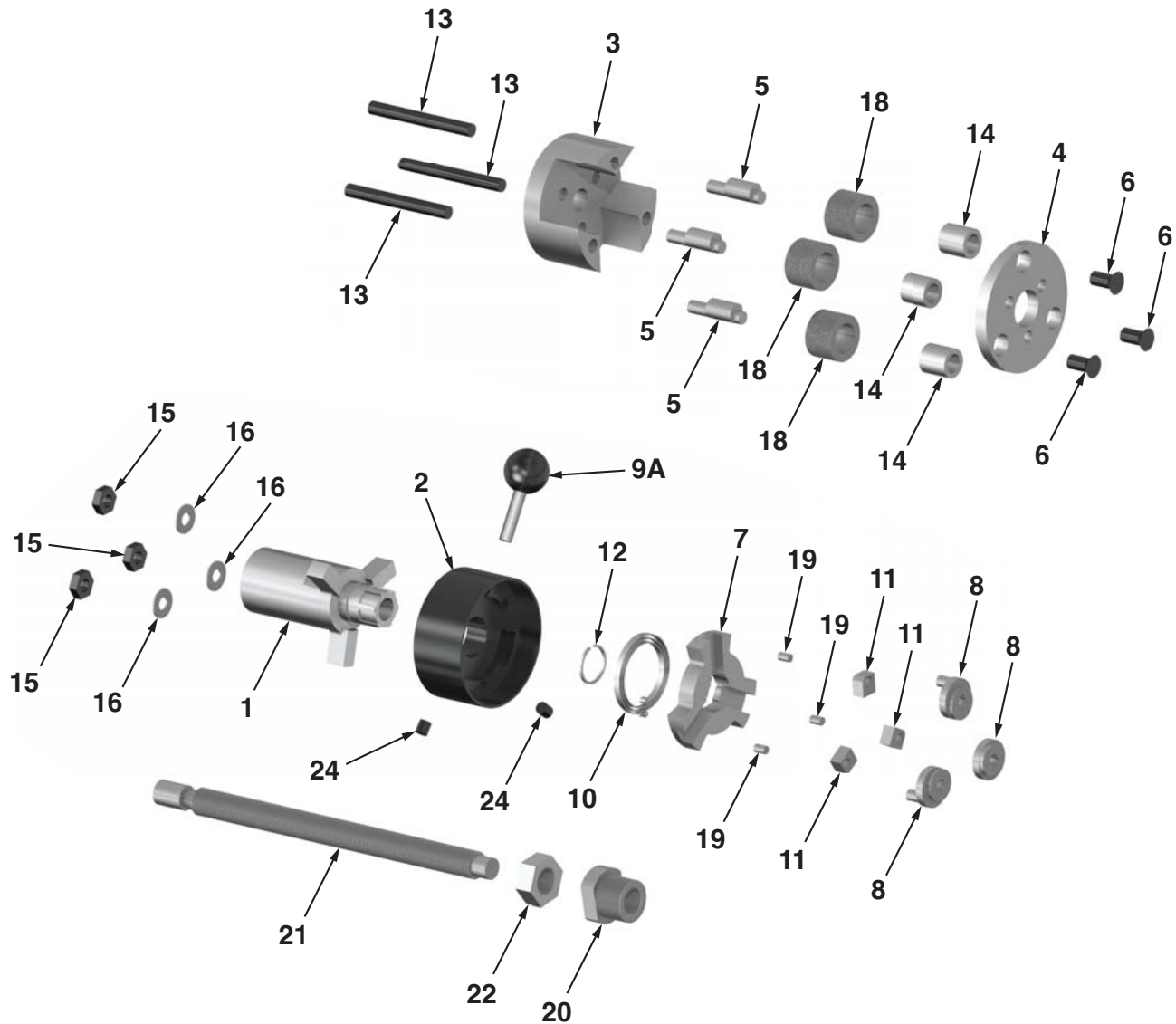

Ref	Qty	Description	EDP
1	1	Shank	7544
2	1	Spring Housing	7686
3	1	Center Plate	7526
4	1	Front Plate	7539
5	3	Eccentric Spindle	7531
6	3	Front Plate Screw	7523
7	1	Clutch Plate	7527
8	3	Cam	7525
9A	1	Handle Assy.	7546A

Ref	Qty	Description	EDP
10	1	Coil Spring	7545
11	3	Hardened Slide	7528
12	1	Circlip	7529
13	3	Studs	7532
14	3	Carbide Bushing	1454
15	3	Hexagon Nut	7543
16	3	Washer	7537
17	1	Hexagon Nut	7549

Ref	Qty	Description	EDP
18	3	Thread Roll (See Chart for Size & EDP)	
19	3	Shear Pin	7533
20	1	Stop Screw Body	7535
21	1	Stop Screw	7536
22	1	Hexagon Nut	7519
24	2	Set Screw	7547
25	1	Washer	7548



RSVP Tooling, Inc.

Toll Free: 888-289-7787 • Direct: 815-725-3310

Fax: 815-725-3391 • Email: sales@rsvptooling.com

www.rsvptooling.com